

# 1-Line 2009

## Load Calculation Software

# User's Manual



Copyright 2008  
Durand & Associates

# 1-LINE 2009

COPYRIGHT 2008 - DURAND & ASSOCIATES

This software and manual are protected by Federal Copyright Laws and may not be copied or duplicated for the purpose of resale or distribution. A registered user may copy the template files for their own personal use provided they retain sole possession of such copies.

The **1-Line 2009** software is a spreadsheet template software program for calculating main service switchboard, subpanels, feeder sizes and 1-Line drawings. This program may be used for industrial and commercial loads. The **1-Line 2009** software is for reference purposes only, and Durand & Associates cannot assume any responsibility for the accuracy of the program contents. In using this program the user agrees to hold harmless and wave all claims against Durand & Associates.

## SOFTWARE REQUIREMENTS

1-Line 2009 was created with Microsoft Excel 97. To use these templates you must have Microsoft Excel, Version 97 or later, installed on your computer.

If you are using Excel 2007 please use the 1-Line folder C:\1-Line 2009 Excel 2007

## INTRODUCTION

The **1-Line 2009** software is a spreadsheet template program. The program was designed for use in conjunction with Microsoft Excel on the Windows platform. The program should also work on other platforms that can read and write Microsoft Excel 97 file formats.

## LOADING THE PROGRAM

Insert the CD in your drive and follow the setup instructions.

The installation of 1-Line will create the following folder on your C drive.

C:\1-Line 2009

## EXPLORING THE PROGRAM

1-Line software is a complex spreadsheet template program. The program uses 53 files which link to one another. **DO NOT CHANGE THE FILE NAMES.** If a file name is changed the template can become corrupt.

## LOCATING THE PROGRAM FILES

The 1-Line templates are located on your C: drive.

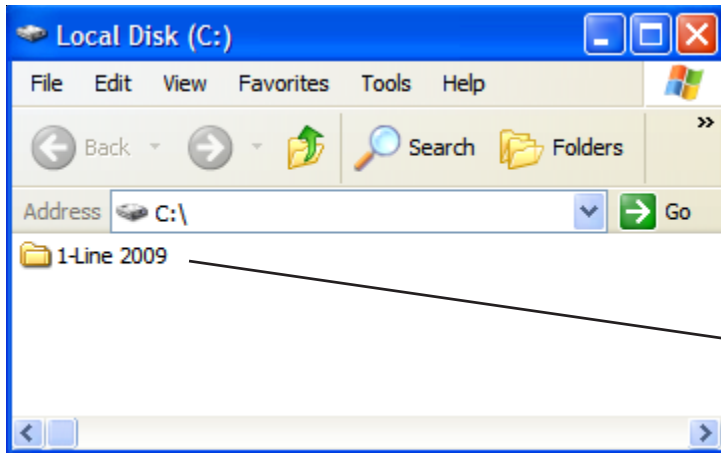

1-Line 2009 Folder

If you double click on the 1-Line folder, you will find 1 folder.

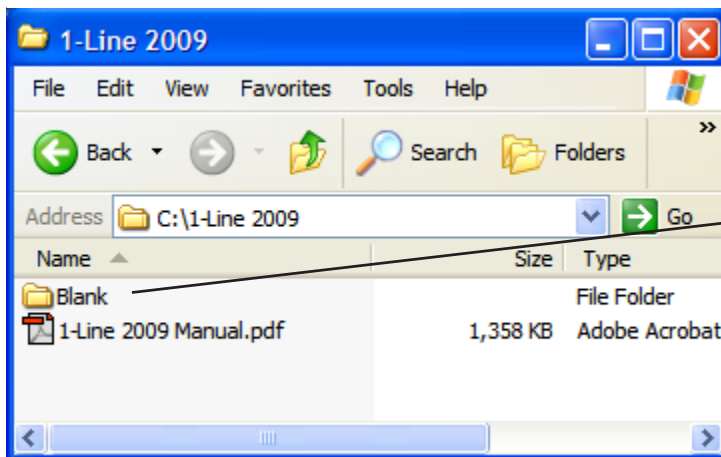

Blank Folder

## STARTING A NEW PROJECT

If you want to start a new project, RIGHT CLICK on the blank folder and select COPY.

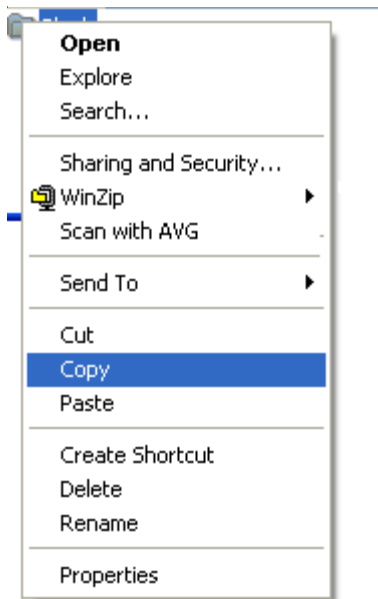

Then RIGHT CLICK on the white area of the window and select PASTE.

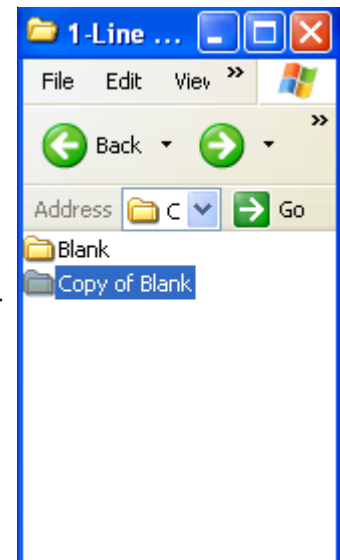
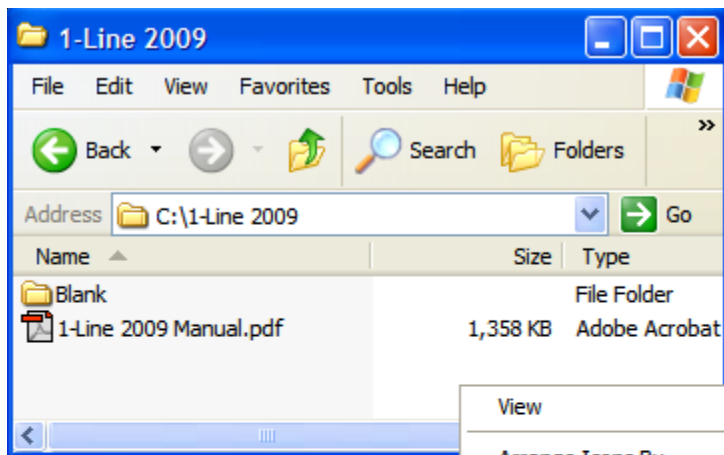

This will create a new folder titled “Copy of Blank”.

## RENAME THE FOLDER

You can RIGHT CLICK on the new folder and select the RENAME command.

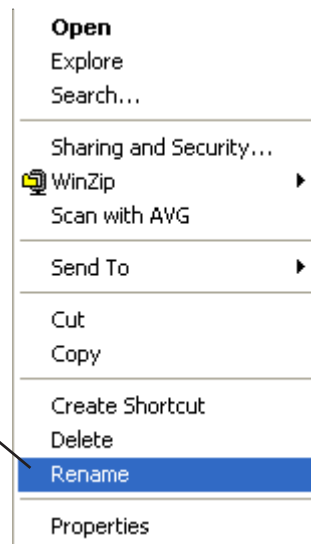

Type in your new project name.



Use this method to create a new project each time you start a new 1-Line.

Now that you have created a new folder close all windows.

## USING THE PROGRAM

Go to your START MENU, select ALL PROGRAMS, and select EXCEL.



This will start your Excel spreadsheet program.

## TURNING ON AUTOMATIC UPDATING IN EXCEL

Go to the Tools menu and select Options

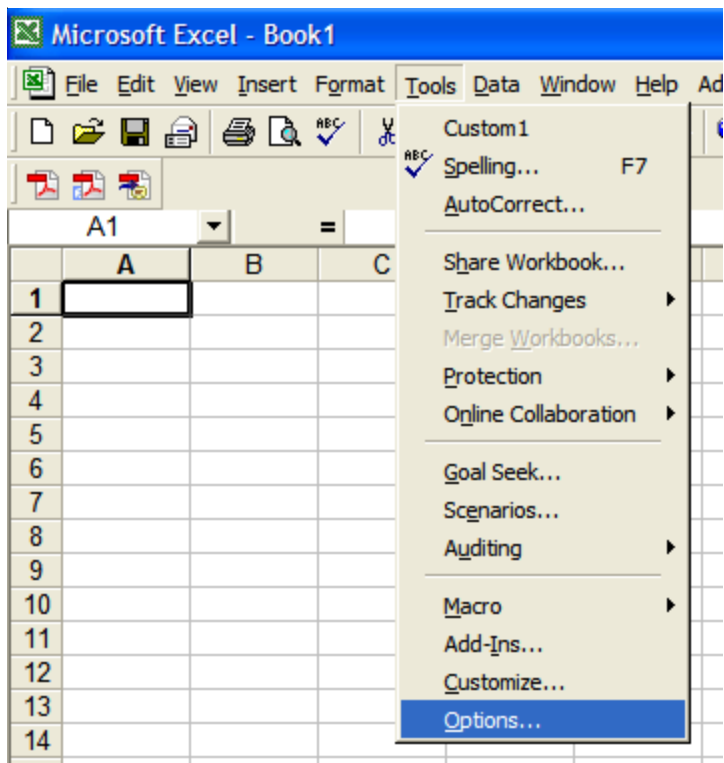

## TURNING ON AUTOMATIC UPDATING IN EXCEL (Continued)

Go to the Tools menu and select Options

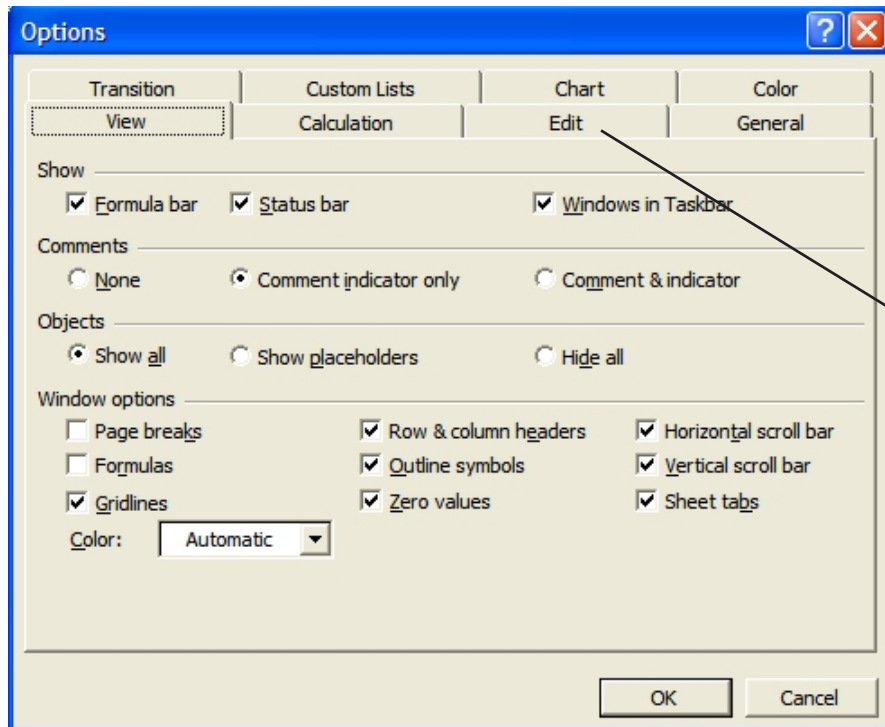

Select the Edit Tab

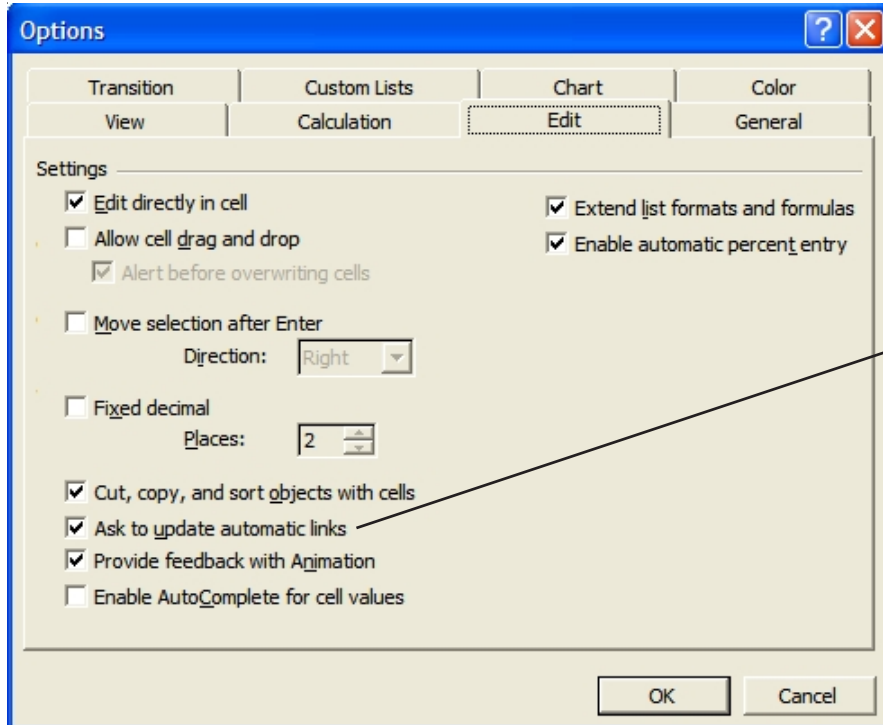

Uncheck the "Ask to update automatic links."

## USING THE PROGRAM

Select the FILE OPEN command and locate the 1-Line 2009 folder on your C: drive. Double click the 1-Line 2009 folder to display the contents.

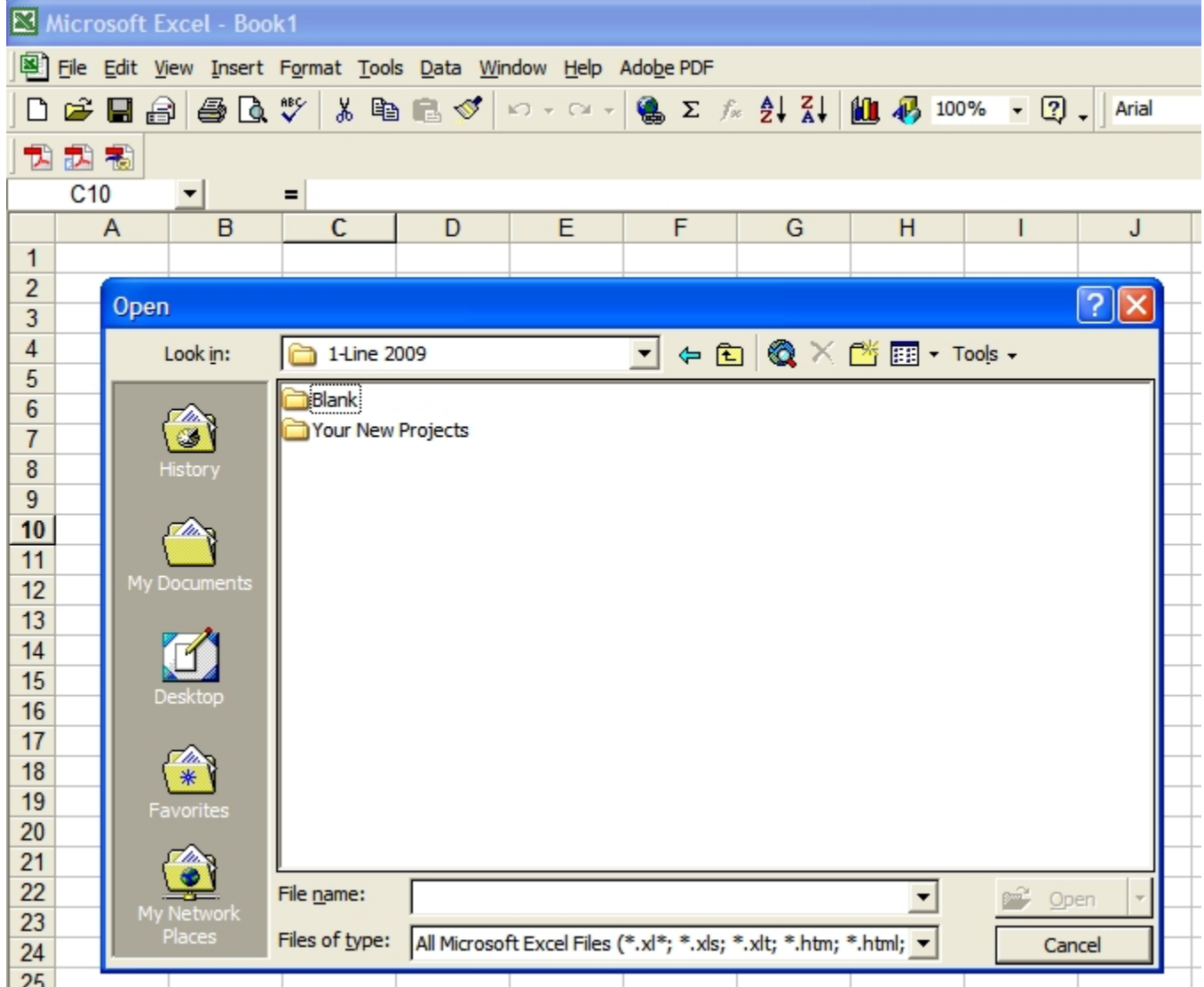

Now displayed are two folders.

1. Blank
2. Your New Project (This is the folder you just created.)

## EXPLORING THE SAMPLE PROJECT

Double click on the YOUR NEW FOLDER to display the contents.

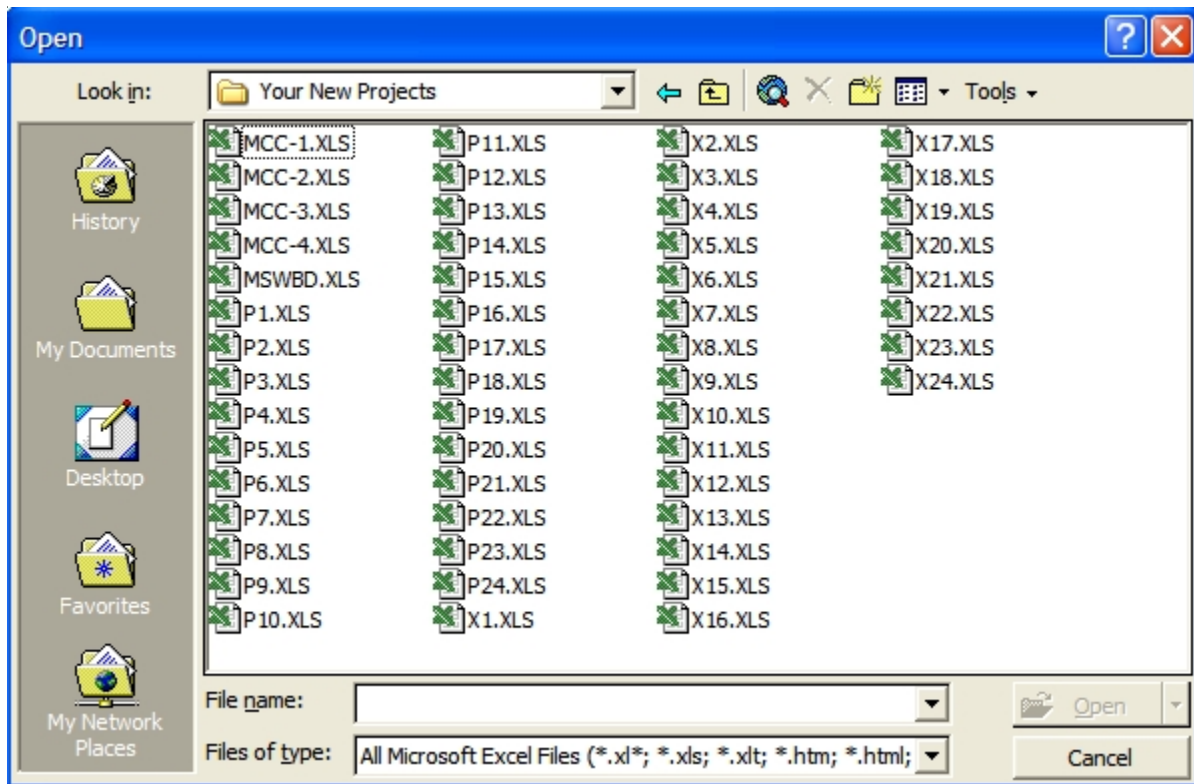

The files in this folder are MSWBD, P1-P24, X1-X24, and MCC 1-4.

MSWBD ( Main Switchboard)

P1 - P24 (Panels)

X1 - X24 (Transformer/Panels)

MCC 1-4 (Motor Control Centers)

**DO NOT RENAME THESE FILES (This will corrupt the files).**

## WORKING WITH THE MAIN SWITCHBOARD (MSWBD)

Double click on the MSWBD file to display the Main Switchboard Template.

This may take a few seconds to open as Excel updates the links to the Panel files.

The screenshot shows a software interface titled "1-Line 2009 Version 9.0A - Copyright Durand & Associates". The main heading is "Main Switch Board". Below it, there is a "CODE YEAR" field with the value "2008". A section titled "General Information" contains a table of fields and their values:

PANEL NAME	MAIN SWITCHBOARD
FED FROM	SERVICE
# OF CIRCUITS	4
HIGH VOLTAGE	480
LOW VOLTAGE	277
PHASE	3Y
NEUTRAL SIZE	FULL
HERTZ	60
MIN AMPS	380
% FACTOR	0
MAIN BREAKER SIZING	MANUAL
ENTER MAIN BREAKER AMPS	400
MAIN BREAKER POSITION	AFTER CT

### GENERAL INFORMATION

- **Code Year** (Select 2002, 2005, or 2008)
- **Panel Name** (Enter the name of the Main Switchboard)
- **Fed From** (Enter the power source for the Main Switchboard)
- **# Of Circuits** (Enter the number of Panels 1-24)
- **High Voltage** (Enter high voltage)
- **Low Voltage** (Enter low voltage)
- **Phase** (Select the phase from the pulldown menu)
  - 1 = 1-Phase
  - 3D = 3-Phase Delta
  - 3Y = 3-Phase Wye
- **Hi-Leg Size** (Select size from pulldown menu)

This option only appears when using a 3-phase delta service. If you select AUTO, the program will size the L2 (Hi-Leg) to the load. If you select FULL, the program will size L2 the same as L1 & L3.
- **Neutral Size** (Select size from pulldown menu)

When MINIMUM is selected, the line to neutral load must be identified with an (N) in the panel templates.
- **Hertz** (Enter Hertz)
- **Minimum Amps** (Enter the minimum amps)

The minimum amps is the smallest size allowed for the service. If the load exceeds the minimum amps, the program will automatically size the service to the correct size.

## GENERAL INFORMATION (continued)

- **Minimum Amps L2** (Enter the minimum amps for L2)  
This option only appears when using a 3-phase delta service and when AUTO is selected for L2 (Hi-Leg). If the load exceeds the minimum amps, the program will automatically size L2 to the correct size.
- **Minimum Neutral Amps** (Enter the minimum neutral amps)  
This option only appears when AUTO is selected for neutral size. If the load exceeds the minimum amps, the program will automatically size the neutral to the correct size.
- **% Factor** (Enter percent factor)  
This factor is used two ways. If you enter 20%, the ampacity of the panel and conductors will be increased 20%. You can also use this factor to correct for voltage drop.
- **% Factor L2** (Enter percent factor for L2)  
This option only appears when using a 3-phase delta service and when AUTO is selected for L2 (Hi-Leg). This factor is used two ways. If you enter 20%, the ampacity of the L2 conductor will be increased 20%. You can also use this factor to correct for voltage drop.
- **Main Breaker Sizing** (Select method)
  - AUTO Program will automatically size main breaker and feeder conductors. When load exceeds 1200 amps, the MANUAL method must be used.
  - MANUAL You enter the conductor and conduit size.
  - NONE If you have seven (7) or more circuits, you must have a main breaker.
- **Main Breaker Amps** (Enter amps)  
This option only appears when the main breaker sizing is set for MANUAL
- **Main Breaker Position** (Select position)  
This option only appears when a main breaker is used.

## DISPLAY OPTIONS

1-Line Display Options	
SHOW MAIN METER	YES
SHOW CURRENT TRANSFORMER	YES
SHOW FAULT CURRENT	YES
SHOW VOLTAGE DROP %	YES
SHOW CONDUIT LENGTH	YES
SHOW LIFER GROUND	YES
SHOW TRUE PHASE CONNECTION	YES

- **Show Meter** (Yes/No)  
If YES is selected, a meter will appear on the 1-Line drawing.
- **Show Current Transformer** (Yes/No)  
If YES is selected, a CT will appear on the 1-Line drawing.
- **Show Fault Current** (Yes/No)  
If YES is selected, fault current will appear on the 1-Line drawing.

## DISPLAY OPTIONS (continued)

- **Show Voltage Drop** (Yes/No)  
If YES is selected, voltage drop % will appear on the 1-Line drawing.
- **Show Conduit Length** (Yes/No)  
If YES is selected, conduit length will appear on the 1-Line drawing.
- **Show Ufer Ground** (Yes/No)  
If YES is selected, Ufer ground will appear on the 1-Line drawing.
- **Show True Phase Connection** (Yes/No)  
If YES is selected, directories and panel schedules will display actual phase.

## SERVICE ENTRANCE FEEDER OPTIONS (AUTO)

When AUTO is selected, the following will be displayed.

Service Entrance Feeder Options	
SERVICE FEEDER SIZING	AUTO
WIRE TYPE	THW
WIRE CU/AL	AL
WIRE TEMP C	75
WIRE LENGTH	20'
CONDUIT TYPE	EMT
OVERHEAD \ UNDERGROUND	OVERHEAD

- **Service Feeder Sizing** (Select Method)
  - AUTO Program will automatically size service entrance conductors. When load exceeds 1200 amps, the MANUAL method must be used.
  - MANUAL You enter the conductor and conduit sizes.
  - NONE No service entrance conductors will be shown.
- **Wire Type** (Select Type)
- **Wire CU/AL** (Select Type)
- **Wire Temp C** (Select Temp)
- **Wire Length** (Enter Wire Length)
- **Conduit Type** (Select Conduit Type)
- **Overhead/Underground** (Select Method)

## SERVICE ENTRANCE FEEDER OPTIONS (MANUAL & CONDUIT)

When MANUAL and CONDUIT are selected the following will be displayed.

OVERHEAD \ UNDERGROUND	OVERHEAD
CONDUIT / BUSWAY	CONDUIT
CONDUIT LENGTH	30'
CONDUIT SIZE	4"
WIRE CU/AL	CU
WIRE TYPE	THHN
WIRE SIZE (L1 & L3)	#500
WIRE SIZE (HI-LEG L2)	#6
WIRE SIZE NEUTRAL	#3
CONDUIT TYPE	EMT
NUMBER OF CONDUITS	1

- **Overhead/Underground** (Select Method)
- **Conduit/Busway** (Select Method)
- **Conduit Length** (Enter Conduit Length)
- **Conduit Size** (Select Size)
- **Wire CU/AL** (Select Type)
- **Wire Type** (Select Type)
- **Wire Size** (Select Size)
- **Wire Size (Hi-Leg) L2** (Select Size)  
This option only appears in the 3-Phase Delta Mode.
- **Neutral Size** (Select Size)
- **Conduit Type** (Select Type)
- **Number of Conduits** (Enter Number)

## SERVICE ENTRANCE FEEDER OPTIONS (MANUAL & BUSWAY)

When MANUAL and BUSWAY are selected the following will be displayed.

OVERHEAD \ UNDERGROUND	OVERHEAD
CONDUIT / BUSWAY	BUSWAY
BUSWAY LENGTH	150'
BUSWAY SIZE	2500 A
BUSWAY CU/AL	CU

- **Overhead/Underground** (Select Method)
- **Conduit/Busway** (Select Method)
- **Busway Length** (Enter Busway Length)
- **Busway Size** (Select Size)
- **Busway CU/AL** (Select Type)

## FAULT CURRENT CALCULATIONS (NONE)

Fault Current Calculations for Incoming Power	
SELECT METHOD	NONE

- **Select Method** (Select Method)

## FAULT CURRENT CALCULATIONS (UTILITY TRANSFORMER INFINITE BUS)

Fault Current Calculations for Incoming Power	
SELECT METHOD	UTILITY TRANSFORMER INFINITE BUS
UTILITY VOLTAGE ADJUSTMENT	1.1
TRANSFORMER KVA	350.0
TRANSFORMER %Z RATING	5.0%
PRIMARY VOLTAGE	13,200

Use this method when the Available Fault Current is not known and the transformer KVA is known.

- **Select Method** (Select Method)
- **Utility Voltage Adjustment** (Enter 1.0 or 1.1)
- **Transformer KVA** (Enter KVA)
- **Transformer % Z Rating** (Enter Rating)

Utility voltages may vary +/- 10% for power. Therefore for worst case conditions enter 1.1 as the utility voltage adjustment.

## FAULT CURRENT CALCULATIONS (TRANSFORMER KNOWN AFC)

Use this method when the primary fault current is known and the transformer KVA is known.

Fault Current Calculations for Incoming Power	
SELECT METHOD	TRANSFORMER KNOWN AFC
AVAILABLE FAULT CURRENT	42,000
UTILITY VOLTAGE ADJUSTMENT	1.1
TRANSFORMER KVA	350.0
TRANSFORMER %Z RATING	5.0%
PRIMARY VOLTAGE	13,200

- **Select Method** (Select Method)
- **Available Fault Current** (Enter AFC)
- **Utility Voltage Adjustment** (Enter 1.0 or 1.1)
- **Transformer KVA** (Enter KVA)
- **Transformer % Z Rating** (Enter Rating)
- **Primary Voltage** (Enter Voltage)

Utility voltages may vary +/- 10% for power. Therefore for worst case conditions enter 1.1 as the utility voltage adjustment.

## FAULT CURRENT CALCULATIONS (NO TRANSFORMER KNOWN AFC)

**This is the most common method and should be used in most projects.**

Use this method when the utility provides the Available Fault Current.

Even if there is a utility transformer, most utilities will give you the fault current on the secondary side and you should use this method.

Fault Current Calculations for Incoming Power	
SELECT METHOD	NO TRANSFORMER KNOWN AFC
AVAILABLE FAULT CURRENT	42,000
UTILITY VOLTAGE ADJUSTMENT	1.1

- **Select Method** (Select Method)
- **Available Fault Current** (Enter AFC)
- **Utility Voltage Adjustment** (Enter 1.0 or 1.1)

Utility voltages may vary +/- 10% for power. Therefore for worst case conditions enter 1.1 as the utility voltage adjustment.

## AUTOMATIC TRANSFER SWITCH & ENGINE GENERATOR

Automatic Transfer Switch & Engine Generator ( Located at Circuit Position C1 )	
AUTOTRANSFERSWITCH	YES
TRANSFER SWITCH SIZING	MANUAL
SIZE OF TRANSFER SWITCH (AMPS)	200
ATS DISTANCE FROM MSWBD	50'
ENGINE GENERATOR	YES
GENERATOR SIZING	MANUAL
KW OF GENERATOR	200
GEN-SET DISTANCE FROM ATS	25'

- **Auto Transfer Switch** (Select Yes or No)
- **Size of Transfer Switch** (Enter Amps)
- **ATS Distance from MSWBD** (Enter Distance in Feet)
- **Engine Generator** (Select Yes or No)
- **Generator Sizing** (Select Manual or Auto)
- **KW of Generator** (Enter KW)
- **Genset Distance from ATS** (Enter Distance in Feet)

## IDENTIFY CIRCUIT LOADS

Use the pulldown menu to identify your circuit loads.

- **Panel** When you choose Panel, all load calculations forward from the Panel Template.
- **Xmfr** When you choose Xmfr, all load calculations forward from the Xmfr Panel Template.
- **Space** When you choose Space, a space is shown on the 1-Line.
- **Spare** When you choose Spare a spare circuit breaker is shown on the 1-Line.
- **Manual** When you choose Manual, you may input manual load on the M-Loads tab and the M-Feeders tab.
- **MCC** May be selected for the first four (4) circuits. C1, C2, C3, or C4  
When you choose MCC, all load calculations forward from the Motor Control Center Template.

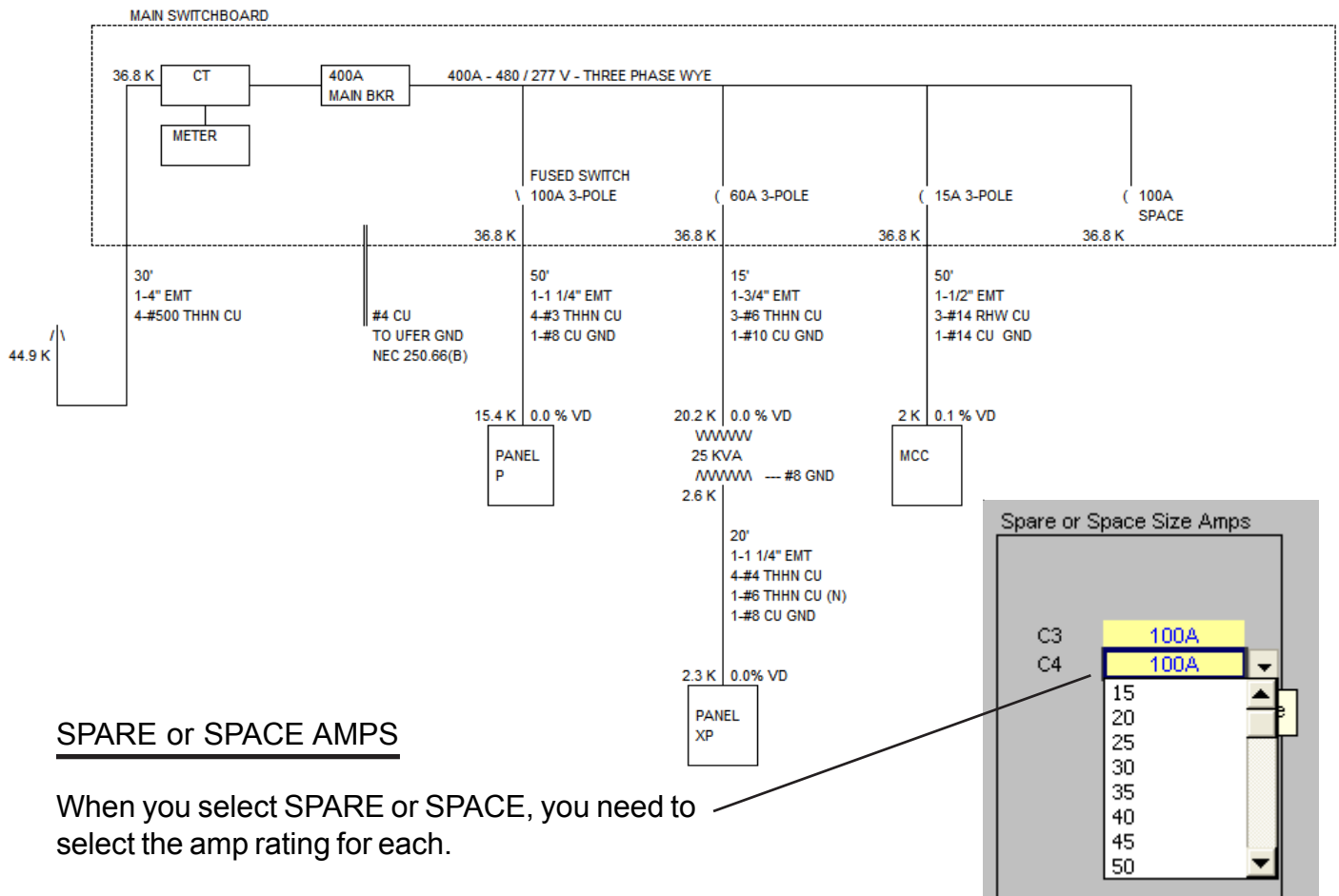
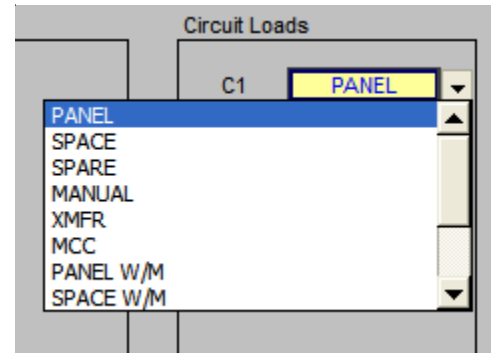

### SPARE or SPACE AMPS

When you select SPARE or SPACE, you need to select the amp rating for each.

## IDENTIFY CIRCUIT LOADS - WITH METERS SHOWN

Use the pulldown menu to identify your circuit loads with meters.

- **Panel w/m** When you choose Panel w/m, all load calculations forward from the Panel Template.
- **Xmfr w/m** When you choose Xmfr w/m, all load calculations forward from the Xmfr Panel Template.
- **Space w/m** When you choose Space w/m, a space is shown on the 1-Line.
- **Spare w/m** When you choose Spare w/m a spare circuit breaker is shown on the 1-Line.
- **Manual w/m** When you choose Manual w/m, you may input manual load on the M-Loads tab and the M-Feeders tab.
- **MCC** May be selected for the first four (4) circuits. C1, C2, C3, or C4  
When you choose MCC w/m, all load calculations forward from the Motor Control Center Template.

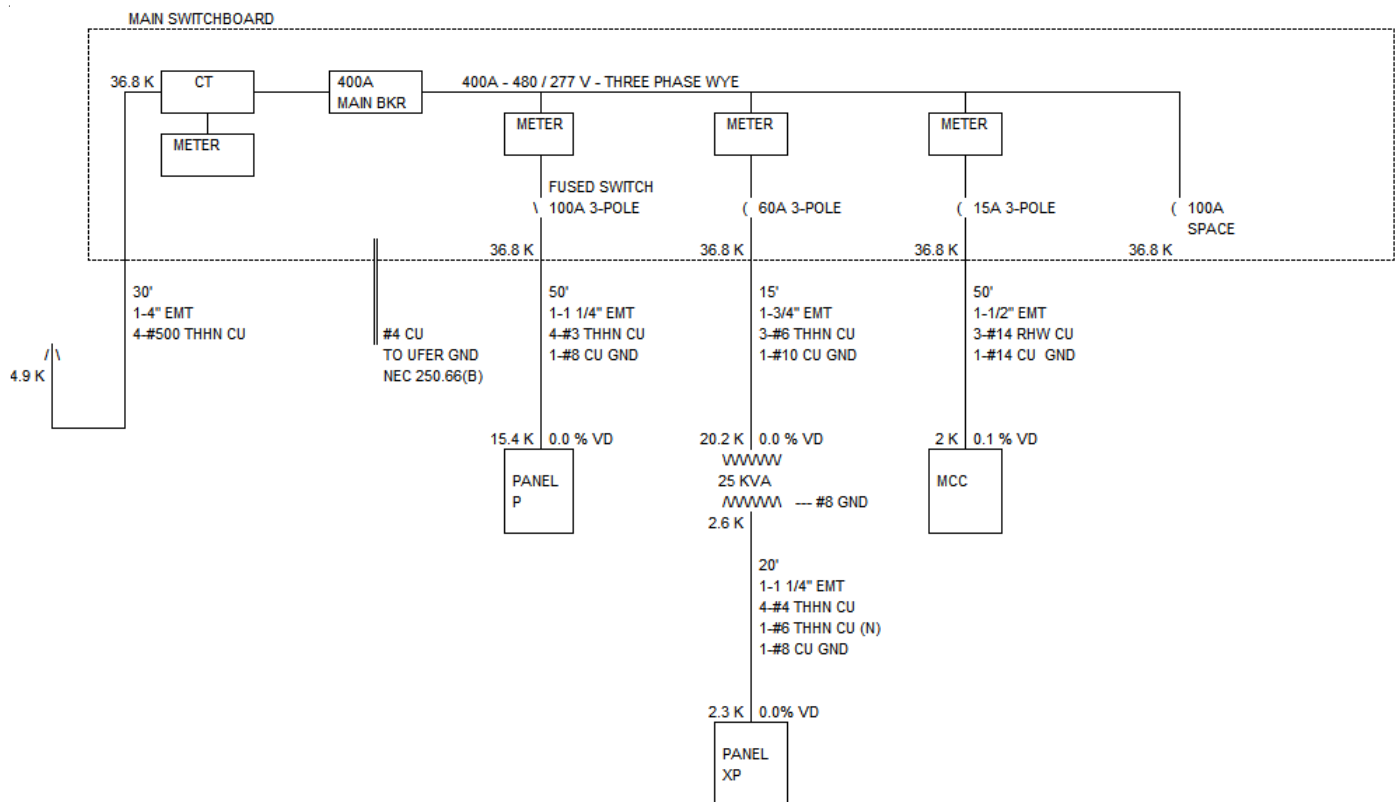
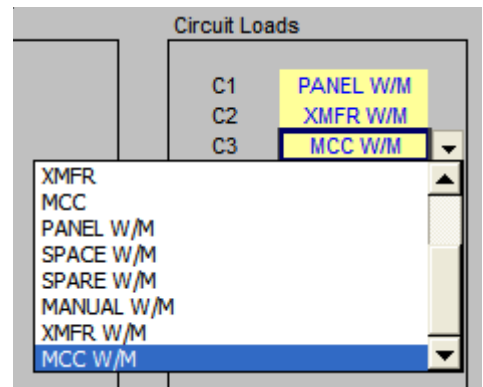

## IDENTIFY OVERCURRENT DEVICE

Use the pulldown menu to identify your overcurrent device

- **Breaker**      |  
                          | 100A 3-POLE
  
- **Fuse**            |  
                          | FUSED SWITCH  
                          | 100A 3-POLE

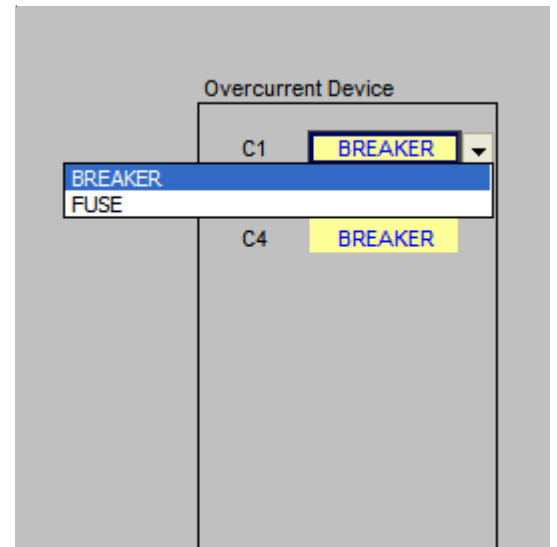

## MANUAL LOADS

If you select MANUAL, you may enter the load and feeder information on the M Load tab and the M Feeder tab.

### M Load Tab

Manual Loads Input									
CIR	DESCRIPTION OF LOAD	SYMBOL	PHASE	BREAKER OR FUSE	BREAKER OR FUSE AMPS	(L2) HI-LEG FUSE AMPS	VA CONNECTED LOAD		
							L1	L2	L3
1									
2	LOAD 2	DISCONNECT	1	FUSE	20			0	0
3									
4									
5									
6									
7									
8									
9									
10									
11									
12									

### M Feeder Tab

Manual Feeder Input											
CIR	DESCRIPTION OF LOAD	NUMBER OF CONDUITS	LENGTH OF CONDUIT	CONDUIT SIZE	CONDUIT TYPE	WIRE TYPE	WIRE CU or AL	WIRE SIZE	WIRE SIZE (L2)	WIRE SIZE NEUTRAL	WIRE SIZE GROUND
2	LOAD 2	1	60'	1 1/2"	RIGID	THHN	CU	#8		#1	#6
3											
4											
5											
6											
7											
8											
9											
10											
11											
12											
13											
14											
15											
16											
17											
18											
19											
20											
21											
22											
23											
24											

## LINKED FILES

The MSWBD file and all Panel files are linked back and forth. File links are only updated when the files are open. If the file is closed and information is change, the closed file will not update formula calculations. When this happens a link update color of orange will appear on your MSWBD template.

### Example

C1	PANEL	<< UPDATE
C2	MANUAL	
C3	SPACE	
C4	SPARE	
C5	SPACE	
C6	PANEL	<< UPDATE
C7	PANEL	<< UPDATE
C8	PANEL	<< UPDATE
C9	PANEL	<< UPDATE
C10	PANEL	<< UPDATE
C11	PANEL	<< UPDATE
C12	PANEL	<< UPDATE
C13	PANEL	<< UPDATE
C14	PANEL	<< UPDATE
C15	PANEL	<< UPDATE
C16	PANEL	<< UPDATE
C17	PANEL	<< UPDATE
C18	PANEL	<< UPDATE

To avoid this you may want to open all active files.

(SEE NEXT PAGE)

## OPENING MORE THAN ONE FILE

Let's say you have a main switchboard and 6 panels.

1. Start your Excel program.
2. Select Open
3. When the files appear, use the mouse to select the MSWBD files and P1-P6 files.

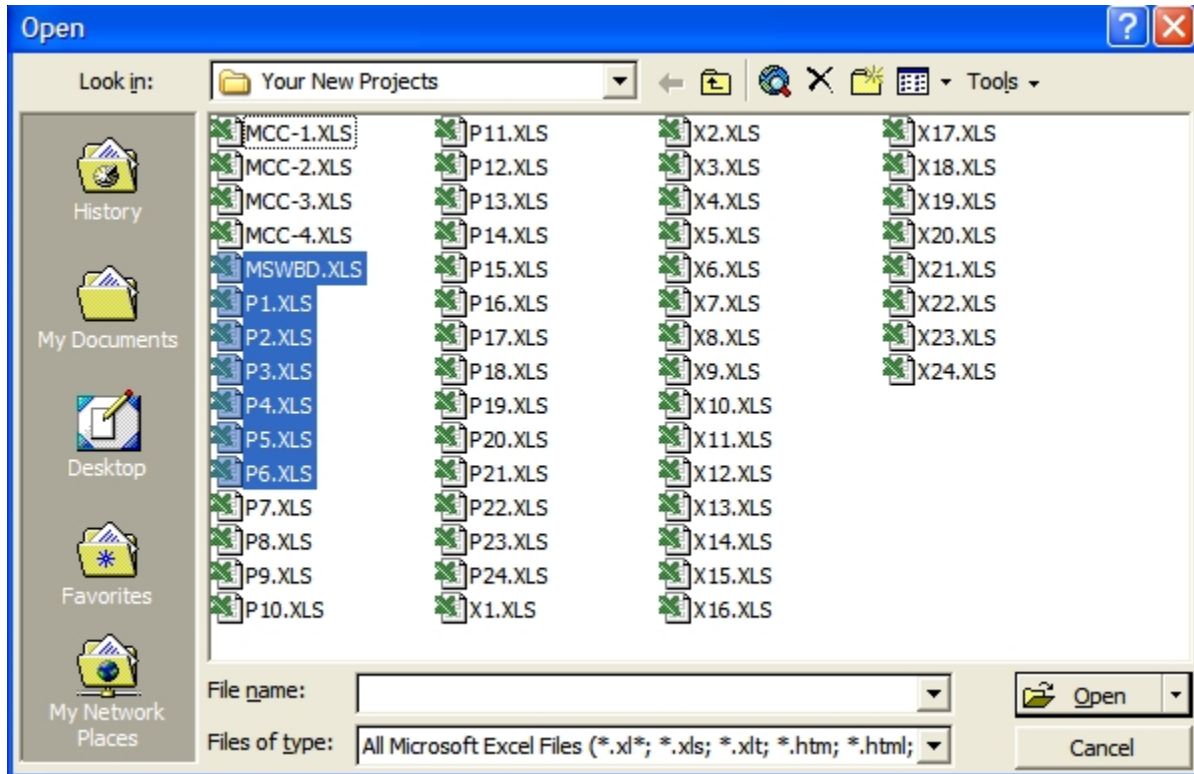

4. Then click on OPEN.

When these files are open, all linked formulas will update automatically.

## PRINTING LOAD CALCS

If you want to print the load calculations, click on the CALCS tab and use the FILE and PRINT command.

## PRINTING THE 1-LINE

If you want to print the 1-Line calculations, click on the 1-LINE tab and use the FILE and PRINT command.

You may want to use the PRINT PREVIEW command to make sure the 1-Line fits on the page. If it prints on more than one page, you may have to adjust the percentage (%) under PAGE SETUP.

NOTE: The 1-Line printout may produce additional blank pages.

## CREATING PDF FILES

If you wish to create PDF files of printouts, you will need to have Adobe Acrobat.

If you have Adobe Acrobat, a Create Adobe PDF command appears under the FILE menu.

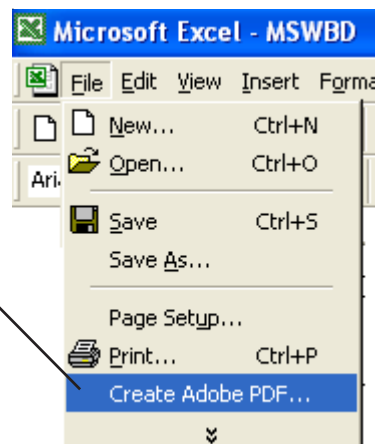

## USING THE PANEL TEMPLATES

There are 24 panel templates P1 through P24. Do not change the name of these files. Each file links to the MSWBD file and forwards all the load calculations. The panel files also read information from the MSWBD files. It is best to have the MSWBD file open when working with the panel files.

## USING THE TABS

The template has twelve (12) tabs.

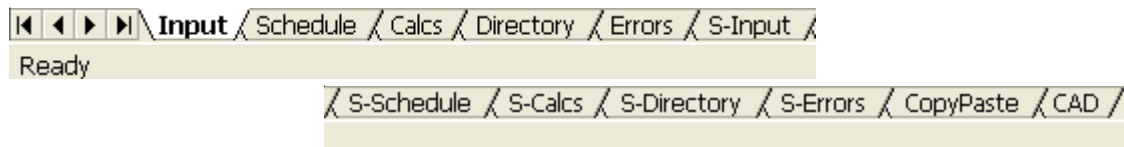

The first five tabs are for the Panel and the second five tabs are for the Subpanel.

Each tab has a special purpose:

### **Panel Tabs**

Input - This sheet is used to enter information.

Schedule - This sheet is used to review and print the panel schedule.

Calcs - This sheet is used to review and print load calculations.

Directory - This sheet is used to review and print the circuit directory.

Errors - This sheet is used to review and print the errors.

### **Subpanel Tabs**

S-Input - This sheet is used to enter information.

S-Schedule - This sheet is used to review and print the panel schedule.

S-Calcs - This sheet is used to review and print load calculations.

S-Directory - This sheet is used to review and print the circuit directory.

S-Errors - This sheet is used to review and print the errors.

### **Misc Tabs**

Copy/Paste - This sheet explains the Paste Values command for Excel.

CAD - This sheet explains how to use the Copy Picture command and paste into a CAD program.

## USING THE XMFR PANEL TEMPLATES

There are 24 XMFR panel templates X1 through X24 do not change the name of these files. Each file links to the MSWBD file and forwards all the load calculations. The XMFR panel files also read information from the MSWBD files. It is best to have the MSWBD file open when working with the XMFR panel files.

## USING THE TABS

The template has twelve (12) tabs.

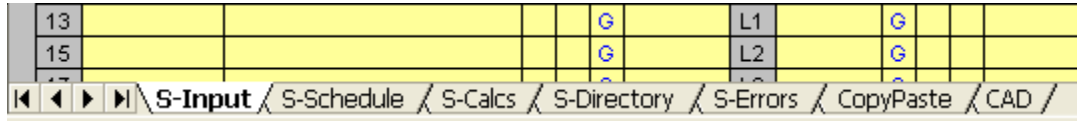

The first five tabs are for the Panel and the second seven tabs are for the Subpanel

Each tab has a special purpose:

### **Subpanel Tabs**

- S-Input - This sheet is used to enter information.
- S-Schedule - This sheet is used to review and print the subpanel schedule.
- S-Calcs - This sheet is used to review and print subpanel load calculations.
- S-Directory - This sheet is used to review and print the subpanel circuit directory.
- S-Errors - This sheet is used to review and print the subpanel errors.

### **Misc Tabs**

- Copy/Paste - This sheet explains the Paste Values command for Excel.
- CAD - This sheet explains how to use the Copy Picture command and paste into a CAD program.

## GENERAL ENTRIES

Some cells in the template files are protected. You may only enter information into certain cells. If you are using a color monitor, these cells are yellow or lime green.

PANEL	P	AFC CALCULATION METHOD	AUTO
FED FROM	MAIN SWITCHBOARD		
# OF CIRCUITS	84		
HI VOLTAGE	480	AFC AT THIS PANEL	20,214
LOW VOLTAGE	277	<b>FEEDER</b>	
PHASE	3Y	NUMBER OF CONDUITS	1
		FEEDER CONDUIT	1"
NEUTRAL SIZE	AUTO	WIRE SIZE L1	#6
MIN NET AMPS	0	WIRE SIZE L2	#6
GND WIRE Y/N	Y	WIRE SIZE L3	#6
WIRE TYPE	THHN	WIRE SIZE NEUTRAL	#6
WIRE CUAL?	CU	WIRE SIZE GROUND	#10
WIRE TEMP C	75	SUB PANEL PHAS	NONE
WIRE LENGTH	15'		
CONDUIT TYPE	EMT		
MINIMUM AMP:	0		
# KITCHEN LOAI	0		
% FACTOR	0		
MAIN BKR / FUS	N		
BREAKER SIZE	NONE		

Yellow Cells

Lime Green Cells

Each unprotected yellow cell requires a user entry. If an invalid entry is made, a RED error message will appear to the left of the entry or an error message will appear in a pop up box.



When you select a cell a hint box will appear.

You may also use the pulldown menu.

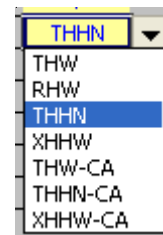

## GENERAL ENTRIES (continued)

Below is a list of valid entries for the general information section of the panel schedule.

PANEL	<input type="text" value="P1"/>	Enter the panel name such as LPA. If entry is too long it may be cut off when printed. (As a general rule 22 characters are allowed.)
# OF CIRCUITS	<input type="text" value="30"/>	Enter number of circuits. (Even number from 6 to 84) or use the pulldown menu.
PHASE	<input type="text" value="3Y"/>	Enter phase. Note: You may put a 1-Phase panel on a 3-Phase source.
HI-LEG SIZE	<input type="text" value="AUTO"/>	Select Auto or Full. (3-Phase Delta Only)
NEUTRAL SIZE	<input type="text" value="AUTO"/>	Select Auto or Full  Most of the time you will select Full and the neutral conductor will be sized the same as the line conductor.  If you select auto you must identify each line to neutral circuit with a (N) on the panel schedule.
MIN NET AMPS	<input type="text" value="60"/>	You may enter zero and the program will calculate the proper wire size. You may also enter a minimum value and the program will use the minimum value. If the minimum value is less than the neutral load, the program will size the neutral to handle the neutral load. The program will size the neutral to carry at least 34 percent of the line conductors per NEC requirements.
GND WIRE Y/N	<input type="text" value="Y"/>	Enter Y or N. If you enter Y, an equipment ground conductor will be added to the feeder conduit(s).
WIRE TYPE	<input type="text" value="THHN"/>	Select the wire type.
WIRE CU/AL?	<input type="text" value="CU"/>	Enter CU or AL.
WIRE TEMP	<input type="text" value="75"/>	Enter the wire insulation temperature.

## GENERAL ENTRIES (continued)

WIRE LENGTH	<input type="text" value="20"/>	Enter wire length.
CONDUIT TYPE	<input type="text" value="EMT"/>	Select conduit type.
MINIMUM AMPS	<input type="text" value="100"/>	Enter minimum amps. If the load exceeds the minimum amps, the program will automatically size the wire for Code requirements.
MINIMUM AMPS (L2)	<input type="text" value="100"/>	Enter minimum amps for hi-leg (L2). If the load exceeds the minimum amps, the program will automatically size the wire per Code.
KITCHEN LOADS	<input type="text" value="5"/>	Enter the number of kitchen loads.
% FACTOR	<input type="text" value="20"/>	Enter percentage factor. Example: If you enter 20, the program will provide 20% spare capacity for future loads. You may also use this factor to adjust for voltage drop.
% FACTOR (L2)	<input type="text" value="20"/>	Enter percentage factor for hi-leg (L2). Example: If you enter 20, the program will provide 20% spare capacity for future loads. You may also use this factor to adjust for voltage drop.
MAIN BKR / FUSE	<input type="text" value="Y"/>	Enter Y or N. If you enter Y, the program will size the main breaker. If this is a 3-phase delta panel with a reduced size hi-leg (L2), the program will size overcurrent protection using fuses.
SUB PANEL BKR	<input type="text" value="3-PHASE"/>	Select choice from pulldown menu. If you want a subpanel fed from this panel, select 1-Phase or 3-Phase.
BREAKER POSITION	<input type="text" value="1, 3, 5"/>	If you have a subpanel, select the breaker position from the pulldown menu.

## GENERAL ENTRIES (continued)

SHOW VD CALCS

If you want voltage drop calculations to appear on the load calculation printout enter YES.

DATED 2-1-06	
ABC ELECTRIC COMPANY	
FOR SERVICE CALL (555) 626-1800	

You may enter any information in the green cells and it will appear on the panel schedule.

## DISPLAY ONLY

Also, in the general information section there are a group of cells displaying wire and conduit size information. These cells only display information when no errors are present in the template.

AFC AT THIS PANEL	29,241
<b>FEEDER</b>	
NUMBER OF CONDUITS	1
FEEDER CONDUIT	1 1/4"
WMRE SIZE L1	#1/0
WMRE SIZE L2 ( HI-LEG )	#6
WMRE SIZE L3	#1/0
WMRE SIZE NEUTRAL	#6
WMRE SIZE GROUND	#6

## CIRCUIT ENTRIES

Once you have completed the general entries, you may begin making the circuit entries. Each circuit entry consists of the following:

### BREAKER

7	20A-1P	LIGHTING			C	1,600
9	20A-1P	LIGHTING			C	1,600
11	20A-1P	LIGHTING			C	1,600

Enter breaker type.

### CIRCUIT DESCRIPTION

7	20A-1P	LIGHTING			C	1,600
9	20A-1P	LIGHTING			C	1,600
11	20A-1P	LIGHTING			C	1,600

Enter circuit description.  
Page 30

## CIRCUIT ENTRIES (continued)

### 3-PHASE DELTA CIRCUITS

If you are entering 1-phase (line to neutral loads) on a 3-phase delta panel, do not put them in the orange cells.

7	20A-1P	LIGHTING			C	1,600	L1
9					C		L2
11	20A-1P	LIGHTING			C	1,600	L3

Hi-Leg (L2)

No 1-phase (line to neutral) loads.

### LOAD IDENTIFIERS

#### H (HARMONIC LOAD)

On 3-phase wye panels, loads subject to harmonic currents (such as electronic ballast and computer equipment) must be identified by placing an "H" in the harmonic identifier column.

#	BKR	CIRCUIT DESCRIPTION	H	I		
1	20A-1P	LIGHTING	H	C	1,600	
3	20A-1P	LIGHTING	H	C	1,600	
5	20A-1P	LIGHTING	H	C	1,600	

Enter "H" or a space (Space Bar)

### HOW THE PROGRAM CALCULATES HARMONIC LOADS.

When the harmonic load is 50% or more of the load ( on 3-phase wye panels), the, NEC requires the neutral conductor to be considered a current carrying conductor.

Therefore, the feeder conduit has four (4) current carrying conductors and the conductor ampacity must be derated to 80%. The program does this automatically.

## LOAD IDENTIFIERS (continued)

### NEUTRAL LOADS

If you have selected AUTO for neutral sizing, the program will calculate the neutral load and size the neutral separate from the line conductors. This is known as reduced neutral sizing.

For this to work properly you need to identify each line to neutral load in the panel.

#	BKR	CIRCUIT DESCRIPTION	N	H	I	
1	20A-1P	LIGHTING	N	H	C	1,600
3	20A-1P	LIGHTING	N	H	C	1,600
5	20A-1P	LIGHTING	N	H	C	1,600

Enter "N" or a space (Space Bar),

### HOW THE PROGRAM CALCULATES NEUTRAL CONDUCTOR SIZE

In the auto sizing mode the largest line to neutral load is the ampacity used. The neutral conductor is sized on that load or 34% of line conductor ampacity per Code requirements.

### CIRCUIT LOAD IDENTIFIERS

There are several ways to identify loads. Listed below are the options.

- G - General Load
- D - Receptacle Load (Diversity)
- C - Continuous Load
- K - Kitchen Load
- M - Motor Load

#	BKR	CIRCUIT DESCRIPTION	N	H	I	
1	20A-1P	LIGHTING	N	H	C	1,600
3	20A-1P	LIGHTING	N	H	C	1,600
5	20A-1P	LIGHTING	N	H	C	1,600

Enter ( G, D, C, K, or M )

## ENTERING CIRCUIT LOADS

### LINE TO NEUTRAL LOADS (1-Pole Breaker)

#	BKR	CIRCUIT DESCRIPTION	N	H	I		
1	20A-1P	LIGHTING		H	C	1,600	L1
3				H	C		L2
5				H	C		L3

Enter the VA (Volts X Amps) into the cell.

### LINE TO LINE LOADS (2-Pole Breaker)

Enter one half of the VA in each cell.

#	BKR	CIRCUIT DESCRIPTION	N	H	I		
1	60A-2P	AC UNIT			M	6,000	L1
3	X X X	X X X			M	6,000	L2
5				H	C		L3

Example: (50 Amps X 240 Volts) = 12,000 VA  
 (12,000 VA ÷ 2) = 6,000 VA in each cell

### LINE TO LINE LOADS (3-Pole Breaker)

Enter one third of the VA in each cell.

#	BKR	CIRCUIT DESCRIPTION	N	H	I		
1	X X X	X X X			M	4,803	L1
3	50A-3P	AC UNIT			M	4,803	L2
5	X X X	X X X			M	4,803	L3

Example: (40 Amps X 208 Volts X 1.732) = 14,410 VA  
 (14,410 VA ÷ 3) = 4,803 VA in each cell

## SUBPANEL GENERAL ENTRIES

FED FROM

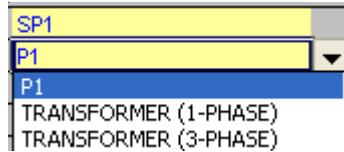

A dropdown menu with a yellow background. The selected item is 'SP1'. The menu is open, showing a list of options: 'P1', 'P1', 'TRANSFORMER (1-PHASE)', and 'TRANSFORMER (3-PHASE)'.

Select Choice

KVA

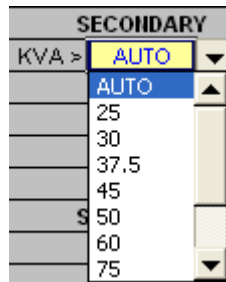

A dropdown menu titled 'SECONDARY'. The selected item is 'KVA > AUTO'. The menu is open, showing a list of options: 'AUTO', '25', '30', '37.5', '45', '50', '60', and '75'.

If you select a transformer, you can select the KVA rating or select AUTO and the program will size the transformer automatically.

VD ADJUSTMENT

If you are using a transformer, a voltage drop adjustment appears. Use this rather than % Factor to adjust for voltage drop.

XMFR % Z RATING

If you are using a transformer, a transformer % Z rating appears. Enter the % Z rating of the transformer.

## PRINTOUTS

Each panel schedule template is designed to print out four (4) sheets for the panel and four (4) sheets for the subpanel.

- Panel Schedule
- Load Calculation
- Directory
- Error Checking Report

Using the mouse, click on the tab to display the sheet you wish to print. When the sheet is displayed, use the FILE/PRINT command.

## NO COPY/PASTE

**Do not use the COPY and PASTE commands on this template as they can corrupt the file.**

Each cell in this template has been formatted with error checking and performance codes. When you copy a cell and use the paste command, these formats and performance codes are pasted to the new location.

PASTE SPECIAL (Values Only)

To avoid corrupting the file use the COPY and the EDIT/PASTE SPECIAL command selecting VALUES from the paste special menu.

Click on "Values"  
and click OK.



## USING THE MOTOR CONTROL CENTER TEMPLATES

There are 4 MCC templates MCC-1 through MCC-4. Do not change the name of these files. Each file links to the MSWBD file and forwards all the load calculations. The MCC files also read information from the MSWBD files. It is best to have the MSWBD file open when working with the MCC files.

## USING THE TABS

The template has five (5) tabs.

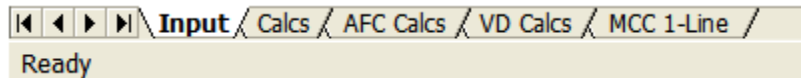

Each tab has a special purpose:

### **Panel Tabs**

Input - This sheet is used to enter information.

Calcs - This sheet is used to review and print load calculations.

AFC Calcs - This sheet is used to review and print the fault current calculations.

VD Calcs - This sheet is used to review and print the voltage drop calculations.

MCC 1-Line - This sheet is used to review and print the MCC 1-Line.

## GENERAL INFORMATION

General Information	
MCC NAME	MCC 1
FED FROM	MSWBD
# OF CIRCUITS	4
CODE YEAR	2008
VOLTAGE	480
PHASE	3Y
HERTZ	60
AVAILABLE FAULT CURRENT	36,902
MINIMUM AMPS	0
GROUND WIRE	YES
WIRE TYPE	RHW
WIRE CU/AL?	CU
WIRE TEMP C	75
WIRE LENGTH	50'
CONDUIT TYPE	EMT
% FACTOR	10%
MAIN DISCONNECT	BREAKER
BREAKER SIZE	30

- **MCC Name** (Enter the name of the MCC)
- **Fed From** (Enter the power source for the MCC)
- **# Of Circuits** (Enter the number of circuits 1-20)
- **Phase** (Select the phase from the pulldown menu)
  - 1 = 1-Phase
  - 3D = 3-Phase Delta
  - 3Y = 3-Phase Wye
- **Minimum Amps** (Enter the minimum amps)

The minimum amps is the smallest size allowed for the service. If the load exceeds the minimum amps, the program will automatically size the service to the correct size.
- **Ground Wire** (Select YES or NO)
- **Wire Type** (Select wire type)
- **Wire CU/AL** (Select CU or AL)
- **Wire Temp C** (Select 60, 75, or 90)
- **Wire Length** (Enter the length of the wire)
- **Conduit Type** (Select conduit type)
- **% Factor** (Enter percent factor)

This factor is used two ways. If you enter 20%, the ampacity of the MCC and conductors will be increased 20%. You can also use this factor to correct for voltage drop.
- **Main Disconnect** (Select BREAKER, FUSED SWITCH, or NON-FUSED SWITCH)

## MOTOR INFORMATION

	MOTOR DESCRIPTION	PHASE	HP	OVERCURRENT PROTECTION	OVERCURRENT % OF FLA
1	MOTOR #1	3Y	1	BREAKER	175%
2	MOTOR #2	3Y	5	BREAKER	175%
3	MOTOR #3	3Y	5	BREAKER	175%
4	MOTOR #4	3Y	5	BREAKER	175%

Enter motor description.

Select Phase.

Select Motor HP.

Select Overcurrent Protection.

Select % of FLA for Overcurrent Protection.

CONDUIT LENGTH	CONDUIT TYPE	WIRE TYPE	WIRE CU/AL	GROUND WIRE	WIRE TEMP	DISCONNECT AT MOTOR
10'	RIGID	THHN	CU	YES	75	YES
20'	RIGID	THHN	CU	YES	75	YES
30'	RIGID	THHN	CU	YES	75	YES
40'	EMT	THHN	CU	YES	75	YES

Enter Conduit Length.

Select Conduit Type.

Select Wire Type.

Select CU or AL.

Select YES or NO.

Select Wire Temp.

Select YES or NO.

END OF USER'S GUIDE